

VALINTA GROOVE



Holistic lighting solution for living cities

Every urban setting has a story to tell. With this belief in mind, we have created VALINTA GROOVE. Designed as both a luminaire for urban lighting and a floodlight for architectural enhancement, VALINTA GROOVE provides aesthetic and technical consistency for all types of application in the city, through various lumen packages, light distributions and LED types (white or RGBCW).

This holistic approach to urban lighting enables city planners, lighting designers and architects to explore the power of VALINTA GROOVE to beautify cities. From basic lighting to peak illumination, VALINTA GROOVE is your ally in revealing and magnifying every detail of the city.

IP 66	IK 09	
	UK CA	CE
		PLUS x x x x 02 x x
	ZD ⁴	



Concept

VALINTA GROOVE is a refined floodlight designed for both urban and architectural lighting. Its sophisticated organic shape, designed by Michel Tortel, brings both charm and character to any urban landscape. More than just a stylish luminaire, VALINTA GROOVE is a flexible lighting solution incorporating cutting-edge technologies, making it the perfect solution for both functional lighting and creation of ambiance.

The body, optic frame and fixation part of VALINTA GROOVE are made of robust die-cast aluminium to withstand the conditions of city life. Available in various sizes, VALINTA GROOVE provides a wide range of lumen packages and light distributions to offer refinement and technical consistency for all types of application in the city.

The luminaire version is equipped with the latest generation of LensoFlex® photometric engines, offering perfect visibility and high efficiency for any urban application, while the floodlight version is equipped with white or coloured LEDs (RGBCW) and collimators dedicated to architectural enhancement. The layout of the RGBCW LED PCBA is inspired by stained glass windows and provides consistency within the lighting installation. Its lighting spectrum is as low as 3 MacAdam ellipses, meaning there are no variations in light or intensity between the floodlights in the installation. As an option, VALINTA GROOVE Mini can feature a GOBO (Goes Before Optics) option, designed to project a large range of images, from sharp logos to detailed art onto any surface.

VALINTA GROOVE is compatible with surface and pole mounting. It has a unique mounting system requiring only one person for a two-step process. The bracket is tiltable. As an option, the photometric engine can be orientated on site over a range of +/- 90°.

VALINTA GROOVE is a smart, connected-ready solution, bringing urban and ambient lighting into the smart era of lighting technologies.



The urban lighting version of VALINTA GROOVE takes advantage of the latest generation of LensoFlex® photometric engines.



The floodlight version of VALINTA GROOVE relies on a unique LED PCBA layout, inspired by historical stained glass windows.



Unique smart mounting system requiring only one person for a quick and easy two-step process.



As an option, the photometric engine can be orientated on site over a range of +/- 90°.

TYPES OF APPLICATION

- URBAN & RESIDENTIAL STREETS
- ACCENT & ARCHITECTURAL
- BRIDGES
- BIKE & PEDESTRIAN PATHS
- RAILWAY STATIONS & METROS
- CAR PARKS
- SQUARES & PEDESTRIAN AREAS

KEY ADVANTAGES

- Versatile platform: floodlight and luminaire
- High energy efficiency and LED consistency (as low as 3 McAdam ellipses)
- Unique mounting system for easy installation on flat surfaces or poles, by one person
- Various cabling options to facilitate application/installation
- Multiple on-site settings (lateral, vertical, optical block) for sharp-edge photometry
- Connected-ready

VALINTA GROOVE | With canon



VALINTA GROOVE | With hood



VALINTA GROOVE | With protection grid



VALINTA GROOVE | With GOBO (Mini size only)





LensoFlex®4

LensoFlex®4 maximises the heritage of the LensoFlex® concept with a very compact yet powerful photometric engine based upon the addition principle of photometric distribution. The number of LEDs in combination with the driving current determines the intensity level of the light distribution. With optimised light distributions and very high efficiency, this fourth generation enables the products to be downsized to meet application requirements with an optimised solution in terms of investment.

LensoFlex®4 optics can feature backlight control to prevent intrusive lighting, or a glare limiter for high visual comfort.

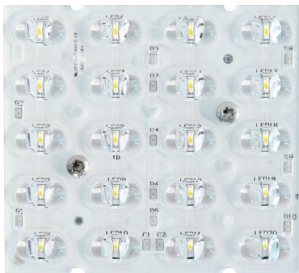



Custom dimming profile

Intelligent luminaire drivers can be programmed with complex dimming profiles. Up to five combinations of time intervals and light levels are possible. This feature does not require any extra wiring.

The period between switching on and switching off is used to activate the preset dimming profile. The customised dimming system generates maximum energy savings while respecting the required lighting levels and uniformity throughout the night.

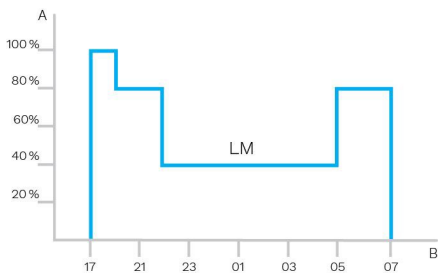

A. Dimming level | B. Time



Dimming through DALI or DMX-RDM

Intelligent luminaire DALI drivers enable to operate dimming profiles. DMX-RDM is a protocol that allows bi-directional communication between a lighting fixture and a controller over a standard DMX line. This protocol allows configuration, status monitoring, and control of the lighting fixture. The standard has been developed by the Entertainment Services and Technology Association (ESTA) and is the current standard on the market.

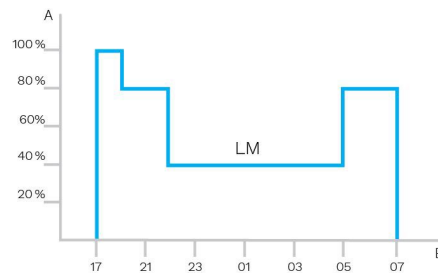

A. Performance | B. Time

The Zhaga consortium joined forces with the DiiA and produced a single Zhaga-D4i certification that combines the Zhaga Book 18 version 2 outdoor connectivity specifications with the DiiA's D4i specifications for intra-luminaire DALI.

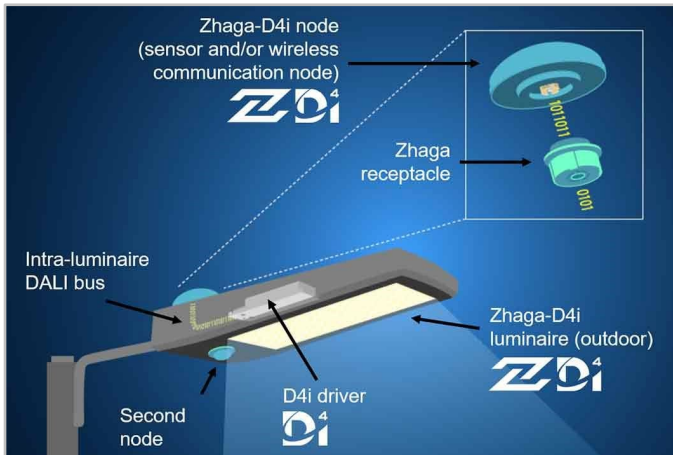

Standardisation for interoperable ecosystems



As a founding member of the Zhaga consortium, Schröder has participated in the creation of, and therefore supports, the Zhaga-D4i certification program and the initiative of this group to standardise an interoperable ecosystem. The D4i specifications take the best of the standard DALI2 protocol and adapt it to an intra-luminaire environment but it has certain limitations. Only luminaire mounted control devices can be combined with a Zhaga-D4i luminaire.

According to the specification, control devices are limited respectively to 2W and 1W average power consumption.

Certification program

The Zhaga-D4i certification covers all the critical features including mechanical fit, digital communication, data reporting and power requirements within a single luminaire, ensuring plug-and-play interoperability of luminaires (drivers) and peripherals such as connectivity nodes.

Cost-effective solution

A Zhaga-D4i certified luminaire includes drivers offering features that had previously been in the control node, like energy metering, which has in turn simplified the control device therefore reducing the price of the control system.

Schröder EXEDRA is the most advanced lighting management system on the market for controlling, monitoring and analysing streetlights in a user-friendly way.



Standardisation for interoperable ecosystems

Schröder plays a key role in driving standardisation with alliances and partners such as uCIFI, TALQ or Zhaga. Our joint commitment is to provide solutions designed for vertical and horizontal IoT integration. From the body (hardware) to the language (data model) and the intelligence (algorithms), the complete Schröder EXEDRA system relies on shared and open technologies. Schröder EXEDRA also relies on Microsoft™ Azure for cloud services, provided with the highest levels of trust, transparency, standards conformance and regulatory compliance.

Breaking the silos

With EXEDRA, Schröder has taken a technology-agnostic approach: we rely on open standards and protocols to design an architecture able to interact seamlessly with third-party software and hardware solutions. Schröder EXEDRA is designed to unlock complete interoperability, as it offers the ability to:

- control devices (luminaires) from other brands
- manage controllers and to integrate sensors from other brands
- connect with third-party devices and platforms

A plug-and-play solution

As a gateway-less system using the cellular network, an intelligent automated commissioning process recognises, verifies and retrieves luminaire data into the user interface. The self-healing mesh between luminaire controllers enables real-time adaptive lighting to be configured directly via the user interface. OWLET IV luminaire controllers, optimised for Schröder EXEDRA, operate Schröder's luminaires and luminaires from third parties. They use both cellular and mesh radio networks, optimising geographical coverage and redundancy for continuous operation.

Tailored experience

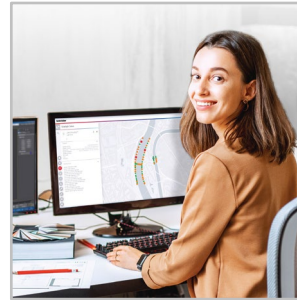

Schröder EXEDRA includes all advanced features needed for smart device management, real-time and scheduled control, dynamic and automated lighting scenarios, maintenance and field operation planning, energy consumption management and third-party connected hardware integration. It is fully configurable and includes tools for user management and multi-tenant policy that enables contractors, utilities or big cities to segregate projects.

A powerful tool for efficiency, rationalisation and decision making

Data is gold. Schröder EXEDRA brings it with all the clarity managers need to drive decisions. The platform collects massive amounts of data from end devices and, aggregates, analyses and intuitively displays them to help end-users take the right actions.

Protected on every side



Schröder EXEDRA provides state-of-the-art data security with encryption, hashing, tokenisation, and key management practices that protect data across the whole system and its associated services. The whole platform is ISO 27001 certified. It demonstrates that Schröder EXEDRA meets the requirements for establishing, implementing, maintaining and continually improving security management.

Mobile App: any time, any place, connect to your street lighting

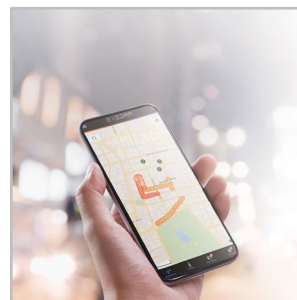

The Schröder EXEDRA mobile application offers the essential functionalities of the desktop platform, to accompany all types of operator on site in their daily effort to maximise the potential of connected lighting. It enables real-time control and settings, and contributes to effective maintenance.

The Mini version of the VALINTA LED floodlight range introduces a GOBO feature, short for "Goes Before Optics". This compact stencilled disc projects a range of images, from logos to intricate drawings, onto surfaces, enhancing both practical and aesthetic lighting environments. Typical applications range from corporate branding, retail displays and signage, to urban beautification projects and public art installations, providing eye-catching lighting solutions for businesses and urban spaces alike.

7049 optic

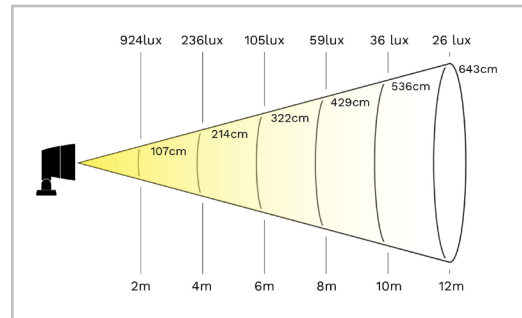

Wide beam 30°

7050 optic

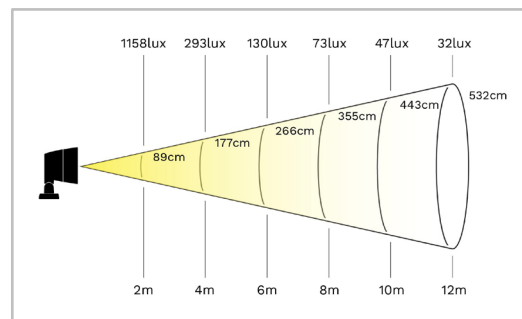

Medium beam 25°

7051 optic

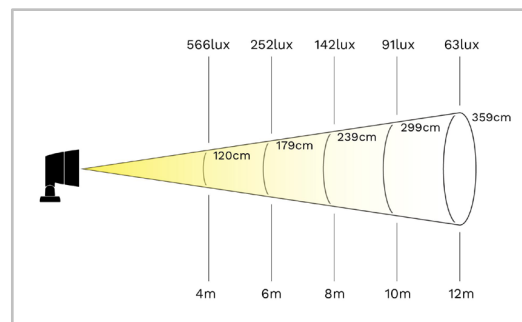

Narrow beam 17°



A quartet of GOBO options



The VALINTA LED floodlight range offers four types of GOBO to meet different lighting needs. Options include:

- Laser-cut stainless steel disc for designs with limited detail.
- Black and white glass offering high resolution for intricate designs, similar to stainless steel but more durable.
- Spot colour glass, perfect for logos, projecting open white designs with spot colours, created by layering white and spot colours.

- Full colour glass for detailed images in full colour using a four-layer CMYK glass printing technique.

These variations allow for tailored lighting applications, from simple branding to complex, colourful images.

Precision floodlighting for every setting



The GOBO version of the VALINTA series incorporates a standard SIZE E GOBO disc, ensuring compatibility and ease of use with an outer diameter (OD) of 37.5mm and an inside image (IA) of 28mm. Combined with a lens that offers three opening angles (17°, 25°, 30°), it allows for customised lighting effects. This adaptability makes it perfect for a variety of settings, from architectural features to event spaces and signage, providing precise illumination of the

unique features of any location.

On-site adjustments



VALINTA the ideal choice for precise lighting effects.

As with all VALINTAs, the GOBO model features tilt and swivel adjustment, to ensure that the projected image is sharp and undistorted by allowing the best projection angle to be selected. The convenience of the easy open mechanism and rotating zoom lens ensures quick focus adjustments on site. A removable magnetic holder makes it easy to change GOBO images. And with optional DMX control, light intensity can be fine-tuned, making

GENERAL INFORMATION

Circle Light label	Score ≥ 90 - The product fully meets circular economy requirements
CE mark	Yes
ENEC certified	Yes
ENEC+ certified	Yes
ROHS compliant	Yes
Zhaga-D4i certified	Yes
RCM mark	Yes
UKCA marking	Yes
Testing standard	EN 60598-1 EN 62262 IEC 62717 (LLM ENEC +) IEC 62722-2-1 IEC 62493 IEC 62471

HOUSING AND FINISH

Housing	Aluminium
Optic	PMMA
Protector	Tempered glass
Housing finish	Standard polyester powder coating (C2-C3 according to the ISO 9223-2012 standard) Optional "seaside" polyester powder coating (C4 according to the ISO 9223-2012 standard)
Tightness level	IP 66
Impact resistance	IK 09
Vibration test	Compliant with modified IEC 68-2-6 (0.5G)

OPERATING CONDITIONS

Operating temperature range (Ta)	-30°C up to +55°C / -22°F up to 131°F with wind effect
----------------------------------	--

· Depending on the luminaire configuration. For more details, please contact us.

ELECTRICAL INFORMATION

Electrical class	Class I EU, Class II EU
Nominal voltage	220-240V – 50-60Hz
Surge protection options (kV)	10
Electromagnetic compatibility (EMC)	EN 55015 / EN 61000-3-2 / EN 61000-3-3 / EN 61547
Control protocol(s)	DALI, DMX-RDM
Control options	AmpDim, Bi-power, Custom dimming profile, Remote management
Socket	Zhaga (optional)
Associated control system(s)	Schröder EXEDRA

OPTICAL INFORMATION

LED colour temperature	2700K (Warm White WW 727) 2700K (Warm White WW 827) 3000K (Warm White WW 730) 3000K (Warm White WW 830) 4000K (Neutral White NW 740) 4000K (Neutral White NW 840) RGB CW
Colour rendering index (CRI)	>70 (Warm White WW 727) >80 (Warm White WW 827) >70 (Warm White WW 730) >80 (Warm White WW 830) >70 (Neutral White NW 740) >80 (Neutral White NW 840) RGB CW

LIFETIME OF THE LEDS @ TQ 25°C

All configurations	100,000h - L80 100,000h - L95
--------------------	----------------------------------

· Lifetime may be different according to the size/configurations. Please consult us.

DIMENSIONS AND MOUNTING

AxBxC (mm inch)	VALINTA GROOVE MINI : 195x296x216 7.7x11.7x8.5 VALINTA GROOVE GOBO MINI : 195x296x216 7.7x11.7x8.5 VALINTA GROOVE MIDI : 266x366x212 10.5x14.4x8.3 VALINTA GROOVE MAXI : 325x430x201 12.8x16.9x7.9
Weight (kg lbs)	VALINTA GROOVE MINI : 5.0-5.5 11.0-12.1 VALINTA GROOVE GOBO MINI : 5.0-5.2 11.0-11.4 VALINTA GROOVE MIDI : 7.1-7.5 15.6-16.5 VALINTA GROOVE MAXI : 10.0-10.5 22.0-23.1
Mounting possibilities	Surface mounting Direct mounting on poles Side-entry penetrating – Ø60mm Post-top penetrating – Ø60mm

· For more information about mounting possibilities, please consult the installation sheet.

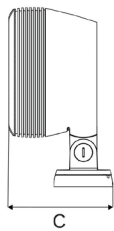
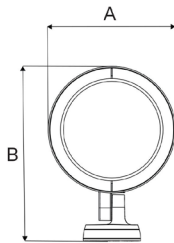

VALINTA GROOVE | Pole mounting – 2 x M8 screws



VALINTA GROOVE | Surface mounting – 3 x M8 screws



VALINTA GROOVE | Penetrating fixation for Ø60mm poles

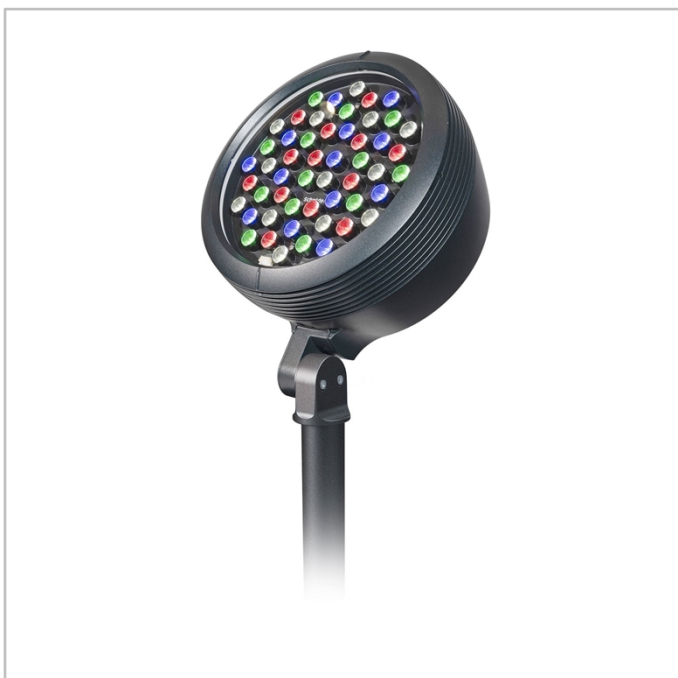



Number of LEDs	Luminaire output flux (lm)								Power consumption (W)		Luminaire efficacy (lm/W)
	RGB CW		Warm White WW 827		Warm White WW 830		Neutral White NW 840		Min	Max	Up to
	Min	Max	Min	Max	Min	Max	Min	Max			
16	1500	2000	1600	4000	1700	4300	1700	4300	6	38	137

Tolerance on LED flux is $\pm 7\%$ and on total luminaire power $\pm 5\%$



Number of LEDs	Luminaire output flux (lm)		Power consumption (W)		Luminaire efficacy (lm/W)
	Min	Max	Min	Max	Up to
1	600	600	28	28	24

Tolerance on LED flux is $\pm 7\%$ and on total luminaire power $\pm 5\%$



Number of LEDs	Luminaire output flux (lm)								Power consumption (W)		Luminaire efficacy (lm/W)
	RGB CW		Warm White WW 827		Warm White WW 830		Neutral White NW 840		Min	Max	Up to
	Min	Max	Min	Max	Min	Max	Min	Max			
28	2200	3000	2400	7100	2500	7600	2500	7600	11	65	134

Tolerance on LED flux is $\pm 7\%$ and on total luminaire power $\pm 5\%$

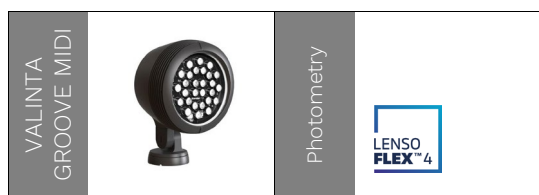

Number of LEDs	Luminaire output flux (lm)								Power consumption (W)		Luminaire efficacy (lm/W)
	Warm White WW 727		Warm White WW 730		Warm White WW 830		Neutral White NW 740				
	Min	Max	Min	Max	Min	Max	Min	Max	Min	Max	
20	2300	5700	2500	6300	2300	5900	2500	6400	20	49	Up to 151

Tolerance on LED flux is ± 7% and on total luminaire power ± 5 %



Number of LEDs	Luminaire output flux (lm)								Power consumption (W)		Luminaire efficacy (lm/W)
	RGB CW		Warm White WW 827		Warm White WW 830		Neutral White NW 840				
	Min	Max	Min	Max	Min	Max	Min	Max	Min	Max	
52	4700	6400	4400	12400	4700	13100	4800	13300	19	110	Up to 145

Tolerance on LED flux is ± 7% and on total luminaire power ± 5 %

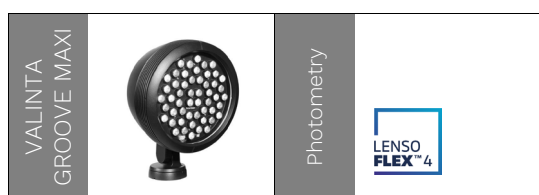

Number of LEDs	Luminaire output flux (lm)								Power consumption (W)		Luminaire efficacy (lm/W)
	Warm White WW 727		Warm White WW 730		Warm White WW 830		Neutral White NW 740				
	Min	Max	Min	Max	Min	Max	Min	Max	Min	Max	
40	4600	10800	5000	11900	4700	11100	5200	12200	38	88	Up to 157

Tolerance on LED flux is ± 7% and on total luminaire power ± 5 %

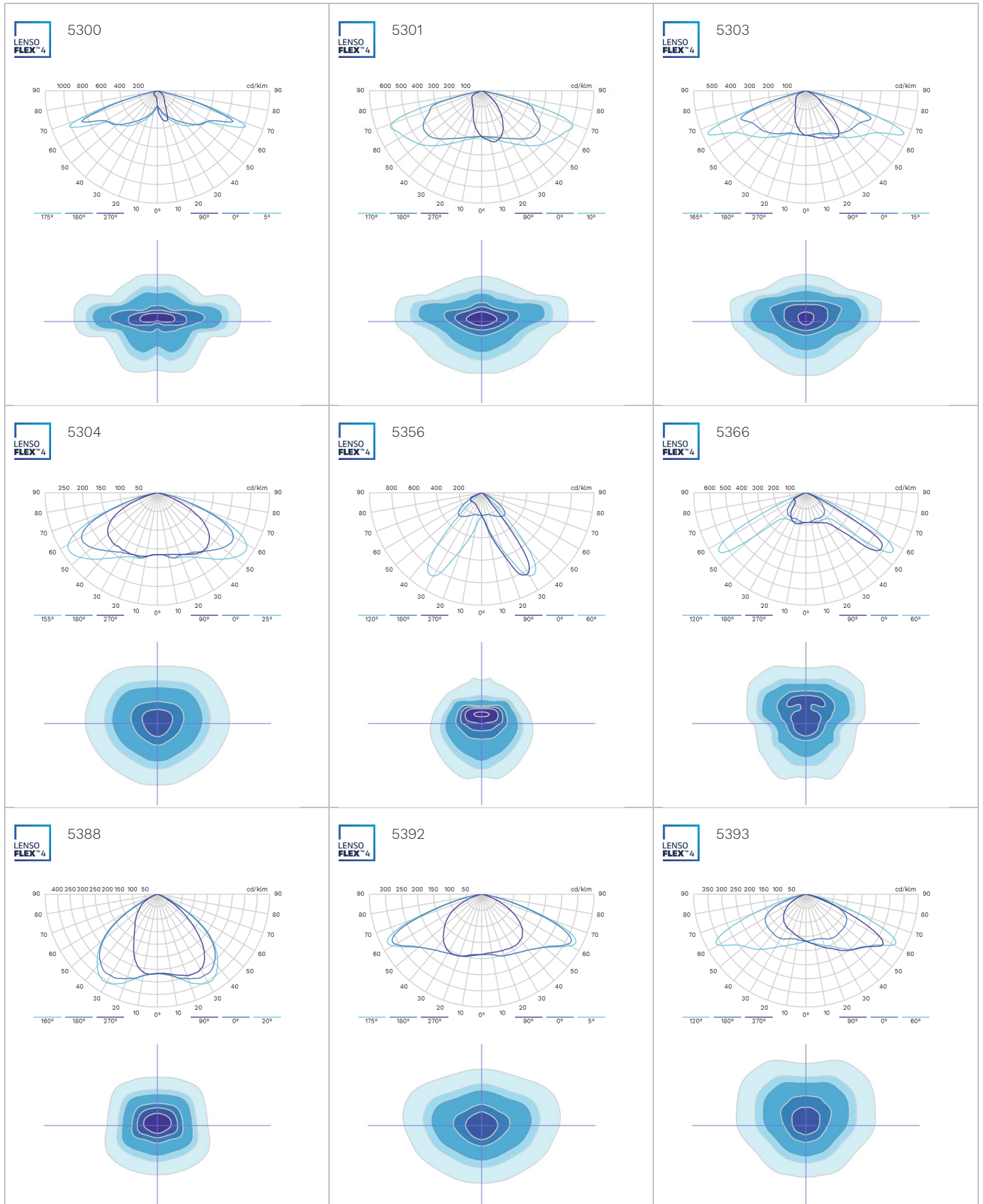



6956 SY

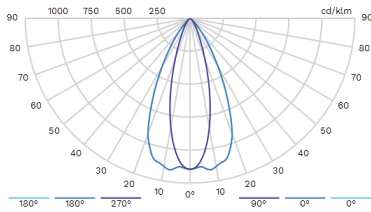

7049 Light Beam 30°

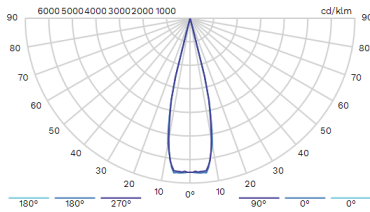

7050 Light Beam 25°

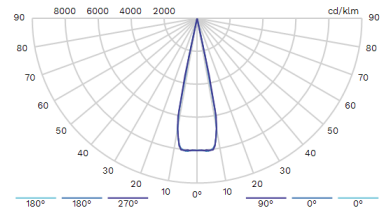

7051 Light Beam 17°

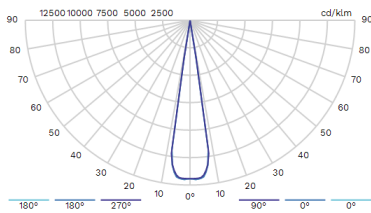

LENSO FLEX⁴ 50001

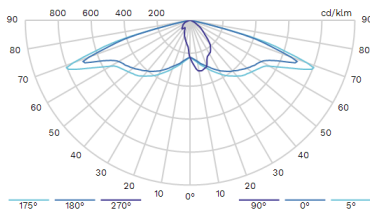

LENSO FLEX⁴ 50004

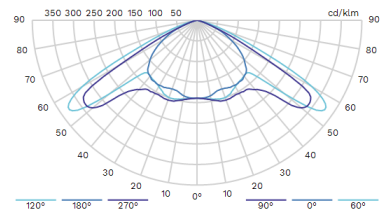

LENSO FLEX⁴ 50008

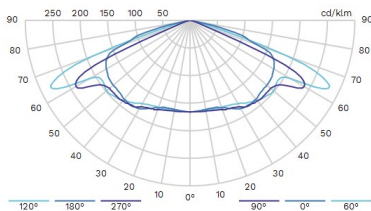

LENSO FLEX⁴ 50009

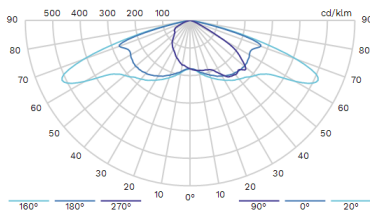

LENSO FLEX⁴ 50010

