

RIVARETO



Modern, energy-efficient square pole for public spaces

RIVARETO is a cost-effective square pole solution developed to enhance visibility and safety in pedestrian areas.

Its modern, streamlined design perfectly integrates into various urban and landscaped environments, such as parks, pedestrian paths, public squares and car parks.

Equipped with high-performance LED technology, RIVARETO delivers uniform, glare-free lighting at ground level, improving visual guidance and pedestrian comfort while maintaining excellent energy efficiency.

Engineered for durability, ease of installation and low maintenance, RIVARETO is the ideal lighting solution for low-height lighting, suitable for both upgrades and new urban development projects.



Concept

RIVARETO's concept relies on an extruded aluminium body that contains the LED engines and gear components. The body is sealed by two aluminium end caps. It provides a high degree of ingress protection and mechanical resistance - perfect for withstanding urban outdoor conditions, especially in low-height applications.

Its modern yet discreet design is available in two sizes, allowing for the creation of a warm ambience without altering the landscape in which it is installed.

Thanks to cutting-edge LED technology, RIVARETO delivers uniform illumination without glare and light pollution, improving spatial awareness for users while keeping energy consumption low. Its durable materials and low maintenance requirements reduce the need for servicing, especially in places that are difficult to reach.

RIVARETO is a complete square pole solution, providing the luminaire and its dedicated column. It benefits from a tool-free, easy-to-use mounting system. Simply pinch the ends of the fixation, insert the luminaire into its square pole and release. RIVARETO is now securely installed and ready to use.

Depending on the need, connection can be made using quick-on connector or cable gland.



Elegant, discreet design that blends into any urban environment.



Highly-efficient LED technology providing glare-free lighting and high visual comfort.



Cost-effective solution providing low energy consumption while supporting sustainable development.



Supplied with a dedicated square pole, RIVARETO includes a quick, easy-to-use mounting system.

TYPES OF APPLICATION

- BIKE & PEDESTRIAN PATHS
- RAILWAY STATIONS & METROS
- CAR PARKS
- SQUARES & PEDESTRIAN AREAS

KEY ADVANTAGES

- Contemporary design
- Highly efficient LED light source
- Maximised savings in energy and maintenance costs
- Robust materials
- Excellent visual comfort (no glare)
- Zhaga-D4i certified

RIVARETO | Mini



RIVARETO | Midi





LensoFlex®2

LensoFlex®2 is based upon the addition principle of photometric distribution. Each LED is associated with a specific PMMA lens that generates the complete photometric distribution of the luminaire. The number of LEDs in combination with the driving current determines the intensity level of the light distribution.

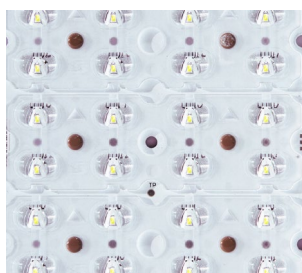



Custom dimming profile

Intelligent luminaire drivers can be programmed with complex dimming profiles. Up to five combinations of time intervals and light levels are possible. This feature does not require any extra wiring.

The period between switching on and switching off is used to activate the preset dimming profile. The customised dimming system generates maximum energy savings while respecting the required lighting levels and uniformity throughout the night.

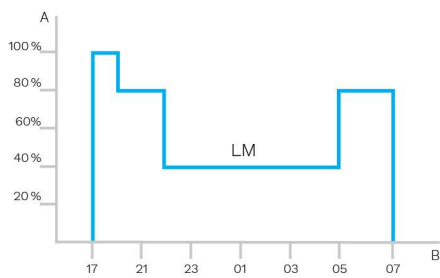

A. Dimming level | B. Time

The Zhaga consortium joined forces with the DiiA and produced a single Zhaga-D4i certification that combines the Zhaga Book 18 version 2 outdoor connectivity specifications with the DiiA's D4i specifications for intra-luminaire DALI.

2 sockets: top and bottom

The Zhaga socket is small and suited to applications where aesthetics is essential. The architecture of Zhaga-D4i also foresees the possibility of putting two sockets on one luminaire, allowing for instance, the combination of a detection sensor and a control node. This also has the added value of standardising certain detection sensor communications with the D4i protocol.

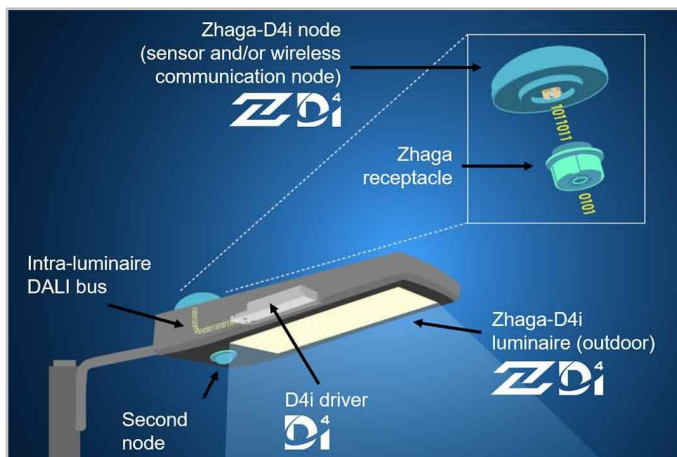

Standardisation for interoperable ecosystems



As a founding member of the Zhaga consortium, Schröder has participated in the creation of, and therefore supports, the Zhaga-D4i certification program and the initiative of this group to standardise an interoperable ecosystem. The D4i specifications take the best of the standard DALI2 protocol and adapt it to an intra-luminaire environment but it has certain limitations. Only luminaire mounted control devices can be combined with a Zhaga-D4i luminaire.

According to the specification, control devices are limited respectively to 2W and 1W average power consumption.

Certification program

The Zhaga-D4i certification covers all the critical features including mechanical fit, digital communication, data reporting and power requirements within a single luminaire, ensuring plug-and-play interoperability of luminaires (drivers) and peripherals such as connectivity nodes.

Cost-effective solution

A Zhaga-D4i certified luminaire includes drivers offering features that had previously been in the control node, like energy metering, which has in turn simplified the control device therefore reducing the price of the control system.

Schröder EXEDRA is the most advanced lighting management system on the market for controlling, monitoring and analysing streetlights in a user-friendly way.



Standardisation for interoperable ecosystems

Schröder plays a key role in driving standardisation with alliances and partners such as uCIFI, TALQ or Zhaga. Our joint commitment is to provide solutions designed for vertical and horizontal IoT integration. From the body (hardware) to the language (data model) and the intelligence (algorithms), the complete Schröder EXEDRA system relies on shared and open technologies. Schröder EXEDRA also relies on Microsoft Azure for cloud services, provided with the highest levels of trust, transparency, standards conformance and regulatory compliance.

Breaking the silos

With EXEDRA, Schröder has taken a technology-agnostic approach: we rely on open standards and protocols to design an architecture able to interact seamlessly with third-party software and hardware solutions. Schröder EXEDRA is designed to unlock complete interoperability, as it offers the ability to:

- control devices (luminaires) from other brands
- manage controllers and to integrate sensors from other brands
- connect with third-party devices and platforms

A plug-and-play solution

As a gateway-less system using the cellular network, an intelligent automated commissioning process recognises, verifies and retrieves luminaire data into the user interface. The self-healing mesh between luminaire controllers enables real-time adaptive lighting to be configured directly via the user interface. OWLET IV luminaire controllers, optimised for Schröder EXEDRA, operate Schröder's luminaires and luminaires from third parties. They use both cellular and mesh radio networks, optimising geographical coverage and redundancy for continuous operation.

Tailored experience

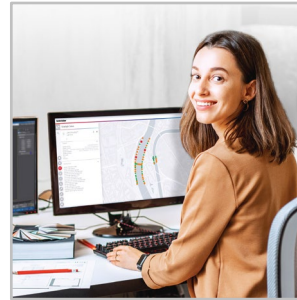

Schröder EXEDRA includes all advanced features needed for smart device management, real-time and scheduled control, dynamic and automated lighting scenarios, maintenance and field operation planning, energy consumption management and third-party connected hardware integration. It is fully configurable and includes tools for user management and multi-tenant policy that enables contractors, utilities or big cities to segregate projects.

A powerful tool for efficiency, rationalisation and decision making

Data is gold. Schröder EXEDRA brings it with all the clarity managers need to drive decisions. The platform collects massive amounts of data from end devices and, aggregates, analyses and intuitively displays them to help end-users take the right actions.

Protected on every side



Schröder EXEDRA provides state-of-the-art data security with encryption, hashing, tokenisation, and key management practices that protect data across the whole system and its associated services. The whole platform is ISO 27001 certified. It demonstrates that Schröder EXEDRA meets the requirements for establishing, implementing, maintaining and continually improving security management.

Mobile App: any time, any place, connect to your street lighting

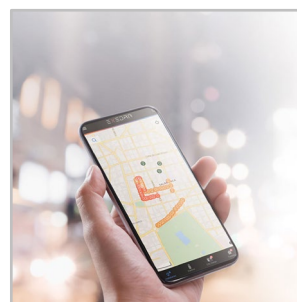

The Schröder EXEDRA mobile application offers the essential functionalities of the desktop platform, to accompany all types of operator on site in their daily effort to maximise the potential of connected lighting. It enables real-time control and settings, and contributes to effective maintenance.

GENERAL INFORMATION

Circle Light label	Score between 60 and 90 - The product meets most of circular economy requirements
CE mark	Yes
UKCA marking	Yes
ENEC certified	Yes
Zhaga-D4i certified	Yes
Testing standard	EN 60598-1 EN 60598-2-1 EN 62262 IEC 62722-2-1 IEC 62493 IEC 62471

HOUSING AND FINISH

Housing	Aluminium
Optic	PMMA
Protector	Tempered glass
Tightness level	IP 66
Impact resistance	IK 09
Vibration test	Compliant with modified IEC 68-2-6 (0.5G)

OPERATING CONDITIONS

Operating temperature range (Ta)	-30°C up to +55°C / -22°F up to 131°F with wind effect
----------------------------------	--

· Depending on the luminaire configuration. For more details, please contact us.

ELECTRICAL INFORMATION

Electrical class	Class I EU, Class II EU
Nominal voltage	220-240V – 50-60Hz
Surge protection options (kV)	10
Control protocol(s)	DALI
Control options	Bi-power, Custom dimming profile
Socket	Zhaga (optional)
Associated control system(s)	Schröder EXEDRA

OPTICAL INFORMATION

LED colour temperature	2700K (Warm White WW 727)
	3000K (Warm White WW 730)
	3000K (Warm White WW 830)
	4000K (Neutral White NW 740)
Colour rendering index (CRI)	>70 (Warm White WW 727)
	>70 (Warm White WW 730)
	>80 (Warm White WW 830)
	>70 (Neutral White NW 740)
ULOR	0%
ULR	0%

· ULOR 0% only for flat glass version.

· ULOR may be different according to the configuration. Please consult us.

LIFETIME OF THE LEDS @ TQ 25°C

All configurations	100,000h - L95
--------------------	----------------

· Lifetime may be different according to the size/configurations. Please consult us.

DIMENSIONS AND MOUNTING

AxBxC (mm | inch) RIVARETO MINI : 258x91x89 | 10.2x3.6x3.5
 RIVARETO MIDI : 421x91x89 | 16.6x3.6x3.5

Weight (kg | lbs) RIVARETO MINI : 2.3 | 5.1
 RIVARETO MIDI : 3.7 | 8.1

Aerodynamic resistance (CxS) RIVARETO MINI : 0.03
 RIVARETO MIDI : 0.04

Mounting possibilities On a dedicated range of poles/brackets

· For more information about mounting possibilities, please consult the installation sheet.

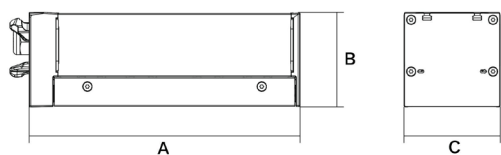

RIVARETO | Complete square pole bollard system with quick, tool-free installation

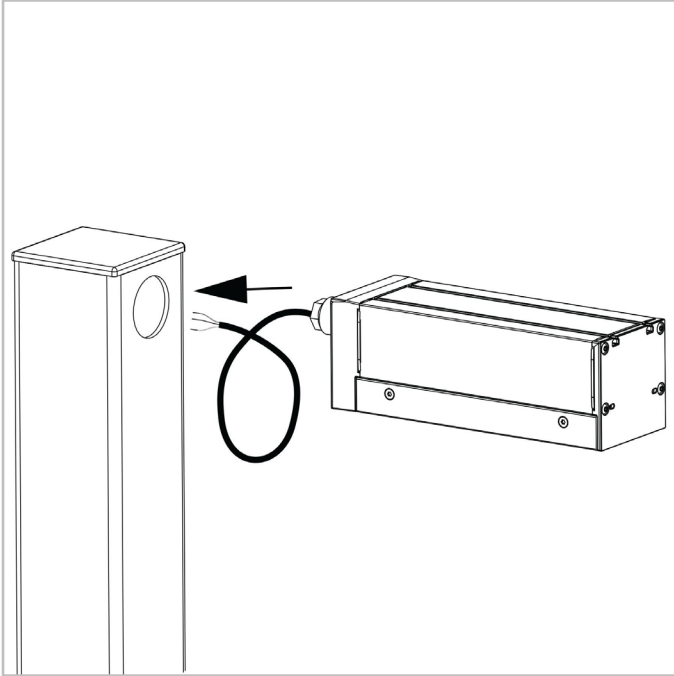

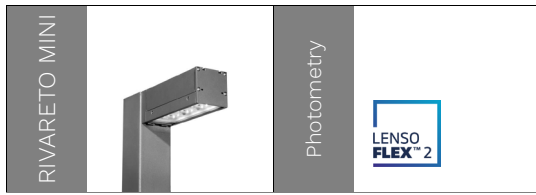

Number of LEDs	Luminaire output flux (lm)								Power consumption (W)		Luminaire efficacy (lm/W)
	Warm White WW 727		Warm White WW 730		Warm White WW 830		Neutral White NW 740				
	Min	Max	Min	Max	Min	Max	Min	Max	Min	Max	Up to
12	800	4300	800	4600	700	4100	900	5000	8	40	149

Tolerance on LED flux is $\pm 7\%$ and on total luminaire power $\pm 5\%$



Number of LEDs	Luminaire output flux (lm)								Power consumption (W)		Luminaire efficacy (lm/W)
	Warm White WW 727		Warm White WW 730		Warm White WW 830		Neutral White NW 740				
	Min	Max	Min	Max	Min	Max	Min	Max	Min	Max	Up to
20	1300	7200	1400	7700	1200	6700	1500	8300	13	64	158

Tolerance on LED flux is $\pm 7\%$ and on total luminaire power $\pm 5\%$

